



Gowing

User manual

Identifier 872FOCSPGWG04ABB119
Version: 4
Date: 27-1-2016

Disclaimer

The content of this manual is furnished for informational use only, is subject to change without notice, and should not be construed as a commitment by Focal Meditech BV. Focal assumes no responsibility or liability for any errors or inaccuracies that may appear in this document. Changes are periodically made to the information herein; these changes will be incorporated into new editions of this publication. Focal may make improvements and/or changes in the products and/or software programs described in this publication at any time.

Copyright Notice

© Focal Meditech BV. All rights reserved.

This manual may only be copied or used within accordance with the terms of the sale agreement of this product. Except as permitted by agreement, no part of this publication may be reproduced, stored in any retrieval system, or transmitted, in any form or by any means, electronic, mechanical, recording, or otherwise, without prior written consent of Focal Meditech BV.

Address comments about this publication to: info@focalmeditech.nl

Trademarks

Focal Meditech is a registered trademark of Focal Meditech BV.

Gowing is a registered trademark of Focal Meditech BV

Content







Disclaimer	2
Copyright Notice	2
Trademarks.....	2
Content	3
Manual introduction	4
Symbol explanation	5
Certifications Notices	6
Safety notices	6
Contact information	6
Intended use and operation of the device	7
Operation of the device	7
Intended use of the device	7
Usage of the device.....	8
Risks and contra-indications	8
Technical information	9
Description	9
Adjusting the arm swing, arm fitting and elbow fitting	10
Disconnect the lever.....	11
Remove the body	12
Remove cables.....	12
Controls	13
Accessories	15
Accessory: Smart Tilt Module	15
Mounting instructions.....	16
Maintenance instructions.....	16
Maintenance hardware.....	16
Cleaning	16
Reuse	16
Decommissioning	16
Appendix 1 Technical specifications	17
Specifications	17
Gowing dimensions	19
Gowing content of case.....	21
Appendix 2 Part numbers	22
Appendix 3 Used materials.....	23
Appendix 4 Mounting instructions Gowing	24
Appendix 5 Quick Chart.....	25
Appendix 6 Troubleshooting guide	26
Appendix 7 Declaration of conformity.....	27
Appendix 8 Conditions and Warranty	28
Conditions and Warranty: supply through a representative of Focal Meditech	28
Conditions and Warranty: direct supply by Focal Meditech BV to consumers	28

Manual introduction



This is the user manual for Gowing, a dynamic arm support system. This product is developed, manufactured and possibly distributed by Focal Meditech B.V. This manual contains the information regarding Gowing, the intended use and the consequences of usage. The aim of this information is to ensure successful, safe and effective use of the device. This manual contains the essential information for using Gowing, safety issues and contact information.

Please read this information carefully: the increase of knowledge of the arm support will result in an increase of the effectiveness. Remark: always keep this user manual in a convenient location for easy reference.







Symbol explanation

Symbols used in user manual	
 <p>Warning!</p>	<p>This symbol is used when there is important information which can help you avoid the risk of serious personal injury or death.</p>
 <p>Disposal</p>	<p>This symbol indicates that this product is not to be disposed of with your household waste, according to the WEEE Directive (2002/96/EC) and your national law. This product should be handed over to a designated collection point, e.g., on an authorized one-for-one basis when you buy a new similar product or to an authorized collection site for recycling waste electrical and electronic equipment (EEE). Improper handling of this type of waste could have a possible negative impact on the environment and human health due to potentially hazardous substances that are generally associated with EEE. At the same time, your cooperation in the correct disposal of this product will contribute to the effective usage of natural resources. For more information about where you can drop off your waste equipment for recycling, please contact your local city office, waste authority, approved WEEE scheme or your household waste disposal service.</p>
<i>Packaging</i>	
 <p>Fragile</p>	 <p>This way up</p>
 <p>Keep away from water</p>	 <p>Do not stack</p>

Certifications Notices

	This is a CE Class I medical device
	This label may not be removed. If the label is removed, warranty will expire. This label is positioned at the bottom side of Gowing
Classification cf. Dutch Cliq 2013:	
241827030309	Dynamic Arm Supports, compensation of diminished muscle function and change of range of motion, load arm construction, hybrid actuation
241827060309	Dynamic Arm Supports, managing excessive muscle functioning, hybrid actuation
241827090309	Dynamic Arm Supports, redistribution of pressure/forces, hybrid actuation
241827990306	Forearm support
241827990900	Axis locking

Safety notices

	Danger:	Prevent direct contact with water or any other liquid. Failure of this can lead to malfunctioning of device or bodily harm
	Danger:	Prevent extreme temperature (see environment conditions). Failure of this can lead to malfunctioning of the device or bodily harm
	Danger:	During installation ensure there is at least a fuse of 5A between power supply and Gowing. Failure of this can lead to malfunctioning of the device and bodily harm
	Warning:	Mechanical energy is stored for balancing the arm. During non-intended removal of the arm from the arm fitting of Gowing, this mechanical energy will be released resulting in a fast moving lever and arm fitting which can result in bodily harm. (more info on page 10).
	Warning:	Do not modify any part of this equipment without authorization of the manufacturer. Failure of this can lead to malfunctioning and loss of warranty
	Warning:	In case of faulty device contact Focal. Do not try to fix it yourself. Failure of this can lead to loss of warranty
	Warning:	In case of doubt about safety of the device contact Focal

Contact information

Gowing is manufactured and sold by

Focal Meditech BV
 Droogdokkeneiland 19
 5026SP Tilburg
 Netherlands
 Tel.: +31 (0)13-533 31 03
 Fax: +31 (0)13-533 50 04
 E-mail: info@focalmeditech.nl
 Internet: www.focalmeditech.nl

Intended use and operation of the device

Operation of the device

The dynamic arm support system Gowing is a system that consists of several axes which are interconnected via pivoting points. At the end of the system an arm fitting, elbow fitting and optional a wrist support are attached. Gowing is mounted on the 'solid' world (chair, wheel chair, movable frame). The under arm of the user is placed in the arm fitting, and Gowing can support the weight of the under and partly the upper arm. The axes of Gowing will support movements of the human under arm and hand.

Gowing has a robust design combined with low friction and low play. This is realised by using high quality bearing systems combined with high accuracy mechanical parts which results in a smoothly running system. Therefore little energy is required to introduce the intended movements. The smooth running Gowing combined with the accurate fit of the arm fitting results in little muscle forces required of the user. The kinematic chain of the axes results in a large range of motion. Gowing is able to support the users even better in bringing the hand towards the mouth and above the head than earlier developed devices of this class. If required personal adaptations can be realised.

The intended users of the dynamic arm support Gowing are:

1. Persons challenged by considerable muscular weakness causing the inability to perform essential Activities of Daily Living (ADL) activities including eating, drinking, facial care, computer use, wheelchair control. No problem solving through application of simple arm supports possible.
2. Persons challenged by excessive muscle functioning – ditto.
3. Persons in the need of redistribution of pressure/forces - ditto.
4. Combinations of these.

In the need of a functional device requiring limited learning efforts.

Intended use of the device

Gowing is a medical device. It is primarily designed for persons having a need for considerable compensation of muscle force. Depending upon personal (dis)abilities Gowing may also diminish the effects of excessive muscle functioning (guide spastic movements). Further, Gowing will redistribute pressures and forces of the arm and shoulder concerned. Gowing is able to introduce dynamic, user controlled force compensation.

Gowing can be used one- or two sided. The selection for one or two Gowings depends on several properties of the user being the personal limitations and possibilities combined with the needs of the user.

The user of Gowing can use this device in various environments like home, workplace, school, institutional setting or outdoor. A restricted tolerance of environmental humidity exists.

Gowing can be mounted on a wheelchair, working chair or stand.

The intended use of Gowing also includes the application as an ergonomic aid for persons who are at risk for Complaints of Arm Neck and-or Shoulder (CANS), overload or strong fatigue due to challenging working conditions, which may be due to continuous or frequent task performance above shoulder level or performance of many static manual activities.

Gowing is not designed to be used in combinations of large forces. Gowing cannot be used as a support when standing up or getting seated or as an autonomous lifting device (without supporting the human arm).





Gowing is not designed to withstand impacts that can be introduced during collisions with a wall or other objects. Also Gowing is not constructed to withstand high external vertical forces that can be introduced for example by (abnormal use of) patient hoist systems.

Usage of the device

Gowing supports the execution of numerous daily activities like eating, drinking, tooth brushing, typing or scratching one's nose. Independence in lifting and manipulating objects and in personal care is possible again. In general it is desirable for users to use their remaining capacities as much as possible. The device adds force to the user's arm when lifting objects in the vertical plane, but (if not in the lifting mode) no more force is added than strictly is needed. The principle at work here is called 'Assist as needed'. Application of this principle is both beneficial from a health perspective and for one's self esteem, furthermore it is also cost effective. Gowing operates on the basis of compensation of the weight of the arm. This is called 'balancing the arm'. The large horizontal movements hardly require any effort anymore. The construction enables easy and quick reach of the mouth and face. Gowing returns the natural freedom of movement to the user. Gowing does not make the wheelchair any wider – not even when the arm of the user is rotated inwards. Gowing allows the user to choose for assisted movements (assist as needed) to move freely or letting the device lift the arm to stabilise the arm.

Risks and contra-indications

No essential user risks are known while using Gowing. Gowing is an aid which should be used by the intended users. However there are no known contra-indications for Gowing. To be able to use Gowing the following warnings must be taken into account.

	Warning:	The arm support system cannot be used by the user as a support when standing up and sitting down. During the evaluation attention is required to determine if the user is able to sit in a stable position and if one can stand-up without using a support.
	Warning:	In case of defects on the electrical wiring, electrical powered parts or the connection to the batteries, contact Focal. In case of doubt about safety of the electronic devices, the product should not be used anymore and should be removed from the (wheel)chair. Do not try to fix it yourself but contact Focal or its national representative. Failure to do this can lead to loss of warranty.
	Warning:	Gowing is before all intended to be used by persons challenged by very limited muscle force in their arms and shoulder girdle. Due to diminished use of their musculoskeletal functions prior to the supply of Gowing and also due to the limited ability to stabilise and control joints, the risk of initial overburden is present. The user is at risk of possible overburden of the arm and shoulder, but the possible risk exists for the whole kinetic chain. The risk of overburden is considered to be the largest shortly after supply of the device when the user experiences new freedom of movement of arm and hand. It is advised to gradually build up deployment of the device in cooperation with a skilled healthcare professional. In collaboration with Focal the user may choose to select settings that initially protect joints that are at risk for overburden.
	Warning:	Gowing does not have parts that can be modified or repaired by the user or other persons. Do not modify any part of this equipment without authorization of the manufacturer. Failure of this can lead to malfunctioning and loss of warranty
	Warning:	For safety reasons, Gowing can only be switched on when the user's arm is correctly positioned in the arm fitting. On the other hand, it is only allowed to switch off Gowing before the user's arm is removed from the arm fitting.

Technical information

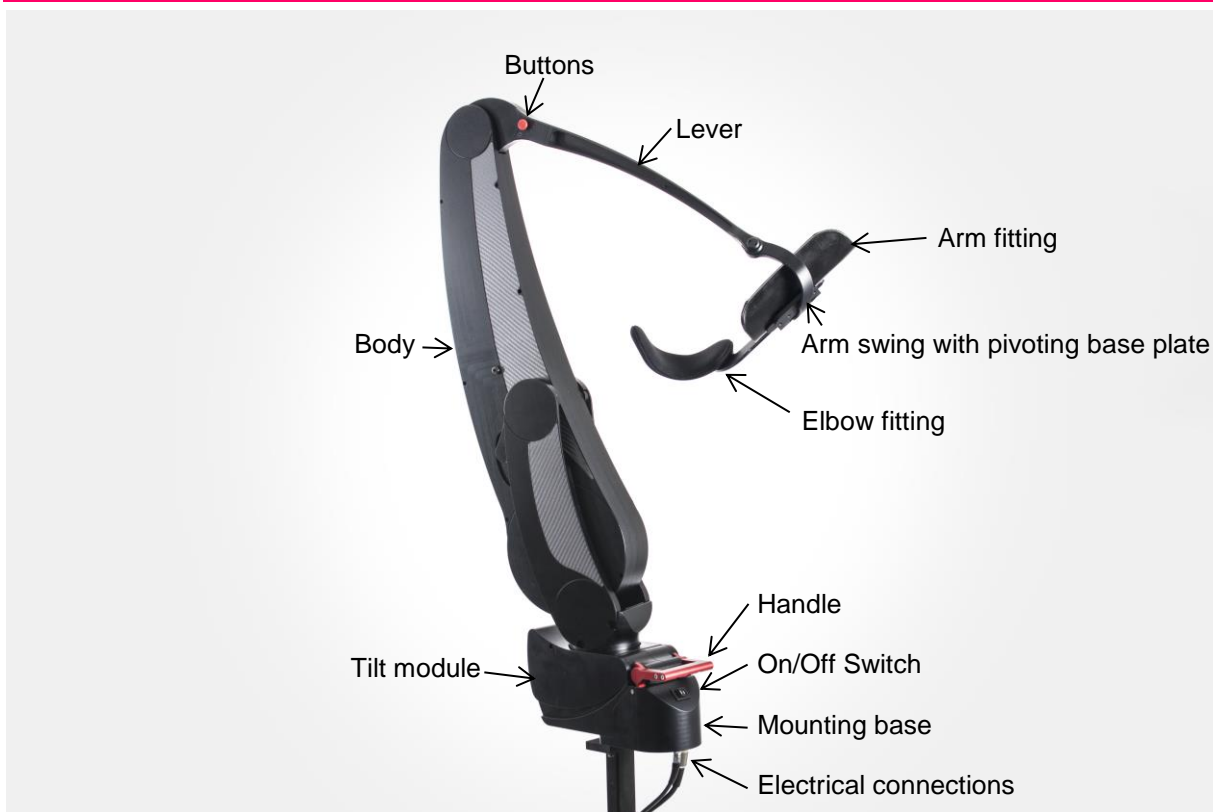

Description

The following parts of Gowling are described

- From a user perspective the contact point with Gowling is the arm fitting where the under arm of the user is positioned in. Therefore this arm fitting is mostly a part that is individually adapted to the user.
- The elbow fitting. The upper arm of the user should be in contact with this part during the use of Gowling.
- The optional wrist support (not on image). This part can be used to support the wrist and hand. This wrist support can be shifted and can be removed. The support itself can rotate.
- The arm swing with pivoting base plate which holds the arm fitting, elbow fitting and the wrist support.
- The lever is connecting the arm, elbow fittings and the wrist support to the body of Gowling.
- At the top of Gowling there are two red buttons. Pressing these two buttons towards each other makes it possible to remove the lever, arm swing containing the arm fitting, elbow fitting and the optional wrist support.
- Body of Gowling. The body of Gowling contains: -the actuator for the lift function. -the actuator to adjust the balance force and -an actuator to operate the blocking mechanism for up/down and forward/backward.
- The tilt module houses -the sensor and actuator for the tilt function; -the blocking mechanism system for the rotation; -and the control electronics. Finally a red handle is attached to this module. This handle can be used to remove the body of Gowling.

	<p>The tilt module can be used to adjust the rotation axis of Gowling with respect to horizontal plane. With help of the tilt module the direction of the white arrow can be adjusted or set to perpendicular to the gravity plane. (The black arrow shows the movement of the tilt module)</p>
---	---



- The mounting base contains the On/Off switch of Gowling. At the bottom side two connectors are present, one for the power supply and one for the Focal bus. These connectors do not have to be disconnected if Gowling is removed using the red handle.

Adjusting the arm swing, arm fitting and elbow fitting

To move the arm freely the weight of the arm is balanced. To balance the arm in the vertical direction, considerable forces are required. For safe use it is important that:

- the arm is positioned in a stable way in the arm fitting
- the arm is always in contact with the elbow rest.

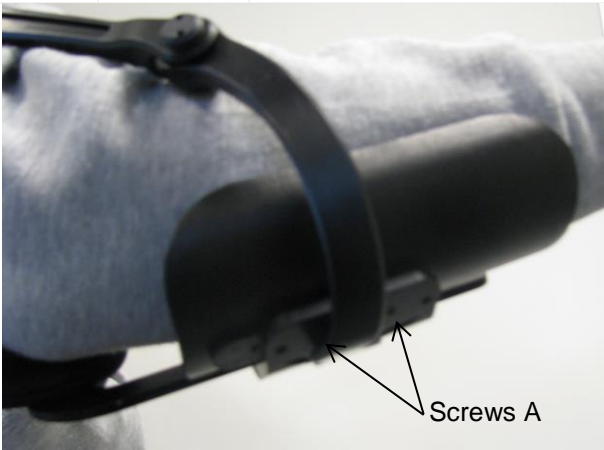
If you notice that the arm is not stable and tends to slip out, reposition the arm in the proper way.

	<p>Warning: The positions of arm fitting and elbow fitting are crucial for the performance of Gowling. Changing these positions can result in a severe decrease of the performance or even malfunction of Gowling. Therefore only trained persons are allowed to change the settings of the arm fitting and elbow fitting.</p>
	<p> Warning: adjusting the arm fitting can result in malfunction of Gowling.</p> <p>The arm fitting can be adjusted in one axis Adjusting the position of the arm fitting is done in the following way: Loosen one or multiple screws (A). Adjust the arm fitting by shifting this fitting. Fasten all screws (A).</p>



Warning: adjusting the elbow fitting can result in malfunction of Gowing for the user.

The elbow fitting can be adjusted in two axes:

1. Adjusting the rotation of the elbow fitting: loosen screw (B) until the fitting can be rotated. Adjust the fitting and fasten the screw (B).
2. Adjusting the position of the elbow fitting: loosen one or multiple screws (C). Adjust the elbow fitting by shifting this fitting. Fasten all screws (C).

Disconnect the lever



The lever including the arm swing, arm fitting, elbow fitting and wrist support can be removed easily. To disconnect the lever, press both red buttons at the top of Gowing, and move the lever away from the body in the upwards direction.

Replacing the lever can be done by pushing the lever into the body. The buttons do not have to be pushed. When the lever is in position, it cannot be removed without pressing the buttons.

Optionally for storage purposes a holder for the lever can be mounted at the back of the wheelchair.

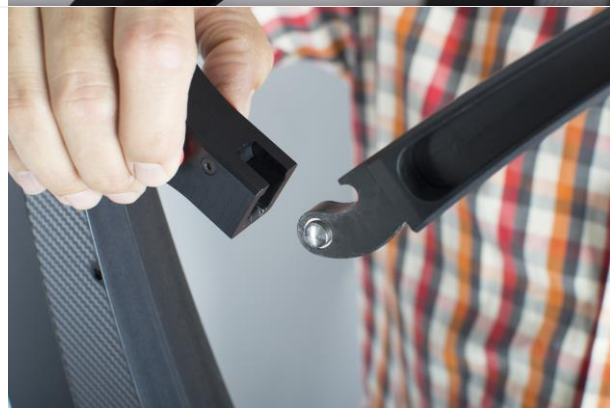

Remove the body



Gowling can easily be removed from the mounting base.

Remove Gowling

- Step 1: Lock Gowling in the storage position¹
- Step 2: Remove the user's arm
- Step 3: Switch off Gowling
- Step 4: Push Gowling with one hand in the direction of the red handle
- Step 5: Lift the red handle upwards with the other hand
- Step 6: Lift the complete Gowling upwards
- Step 7: Store Gowling in its case



Replace Gowling

- Step 1: Position Gowling above the mounting base in such a way that the handle is above the switch
- Step 2: Lower Gowling
- Step 3: Push down the red handle
- Step 4: Position the user's arm in the arm fitting
- Step 5: Switch on Gowling

Remove cables



In case the mounting base of Gowling has to be removed, the two cables must be disconnected first.

To remove the focal bus connector: grab the connector as close as possible inside the mounting base and pull on the connector. The outer part should slide and the connector should slide easy out of the chassis part.





To remove the power connector: grab the connector as close as possible inside the mounting base and turn the outer ring until it is completely free moving. Then pull the connector out of the chassis part.

¹ see Appendix 1 for the layout of the case

Controls

<p>Column A B C</p> 	<p>Gowing has a 9-button interface with illumination for user feedback. The functions are divided in three columns. The 9-button interface is easy to operate. This is why it is an IP40 device which means that it is not water proof. Please cover the interface to avoid direct contact with water.</p>
<p>Column A</p> 	<p>Activating or deactivating the blocking mechanism. Gowing has blocking mechanisms for its up/down movement, forward/backward movement and rotation (in the horizontal plane)². The push button has a toggle function. This means that the blocking mechanism is activated (for all axes) when it was deactivated and vice versa.</p> <p>Incidentally it may appear that not all axes are blocked although the blocking mechanisms are activated. This is due to the mechanical construction (index system) inside Gowing which requires minimal movements for actual blocking. Therefore in such cases a little movement will block the axis as soon as possible.</p> <p>When the blocking mechanism is active, pushing the button will deactivate it. Although the blocking mechanism is deactivated, it can be the case that one or more axes remain blocked. To deactivate the blocking mechanism a little movement is required that will result in a decrease of the force on the blocking mechanism.</p> <p>The design of the blocking mechanism results in the behaviour that the state of Gowing, from blocked to unblocked, will never occur directly when a force is on this mechanism.</p> <p>While the blocking mechanism is activated it is not possible to adjust the balance force or the lift position.</p>
	<p>Two buttons are reserved to adjust the balance force in the vertical plane. Pushing the plus (+) button will result in increasing the balance force. Pushing the minus (-) button will result in decreasing the balance force. The speed of adjustment of the balance force depends on the time the button is pushed. The longer the button is pushed, the faster the adjustment will be.</p>

² The arm swing containing the arm fitting, elbow fitting and the optional wrist support does not have a blocking mechanism. This results in the behaviour that the arm of the user can still swing and rotate in the arm fitting.

Column B		<p>The buttons in column B are used for the tilt function of Gowing. Gowing is able to adjust its position with respect to the gravity in the horizontal plane. (See also pag 15).</p> <p>0-button: pushing this button, Gowing will adjust the tilt module to the position where the rotating axis is set perpendicular to the gravity plane. For most users this will be the best setting.</p> <p>-buttons can be used to adjust the tilt of Gowing. This option can be used to help the arm of the user to have a preferred movement in the forward or backward direction. (This function can change by adding the Smart Tilt Module see pag 15)</p>
Column C		<p>The buttons in column C are used for the lift function of Gowing. Gowing is able to lift the lever and hereby the arm of the user. This means that no force of the user is required to bring the arm to a certain position.</p> <p>0-button: when pushing this button, the lever will go to the lowest position. The user is now able to move the arm freely again.</p> <p>-buttons can be used to adjust the lift position. The speed of adjustment of the balance force depends on the time the button is pushed. The longer the button is pushed, the faster the adjustment will be.</p>

Optional inputs on the UI-Board.

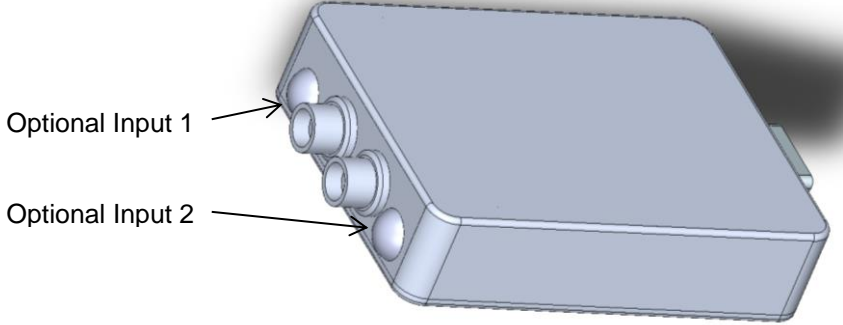

The UI-board has two optional inputs. Where the functionality can be set according to the next table.

Optional input 1	Switch 1
Optional input 2	Switch 2

Function	
Switch 1: Default	Switch 2: Toggle function balancing system
Switch 1: Default	Switch 2: Toggle function lift
Switch 1: Default	Switch 2: Toggle function tilt
Switch 1: Default	Switch 2: Toggle function blockage
Switch 1: Toggle function blockage	Switch 2: Toggle function balancing system
Switch 1: Toggle function blockage	Switch 2: Toggle function lift
Switch 1: Toggle function blockage	Switch 2: Toggle function tilt
Switch 1: Toggle lift	Switch 2: Toggle function balancing system

Accessories

Gowing can be extended with accessories. These accessories can change the function of Gowing or its controls.

Accessory: Smart Tilt Module

As explained in this manual (see pag 15), Gowing is able to adjust the tilting angle with respect to the gravity in the horizontal plane. The Smart Tilt Module can be used to adjust the rotation axis of Gowing with respect to horizontal plane in a much larger range than the integrated tilt module of Gowing is capable of. Where the integrated tilt module of Gowing is able to correct angle between -7 and 7° . The Smart Tilt Module is able to correct for much larger angles ($-60..170$) which results in the possibility to mount Gowing on a seating frame equipped with a stand up function or in situations where the inclination of the seat exceeds 7° .



Accessory: Smart tilt module set

When the Smart Tilt Module is connected to Gowing and its control, the Smart Tilt Module becomes part of the Gowing. This results in the possibility to control the Smart Tilt Module using the Gowing controls.

For safety reasons: the Smart Tilt Module will also prohibit positioning Gowing on angles that are not allowed. If an inclination larger than 10° is measured, the Smart Tilt Module will start to correct for this angle.

Finally, during the startup of Gowing, the Smart Tilt Module will always adjust Gowing to 0° .

In case a Smart Tilt Module is added to Gowing, the function of the buttons in column B will change as described below.



The buttons in column B are still used for the tilt function of Gowing except that these buttons now control the Smart Tilt Module instead of the integrated tilt module of Gowing. But the functions are altered.

0-button: pushing this button shortly: Gowing will adjust the tilt module to the position where the rotating axis is set perpendicular to the gravity plane (vertical).

0-button: pushing this button long (more than 2s) until the beep will sound: Gowing is in automatic mode. Also in this mode Smart Tilt Module will position the Gowing in such a way that the rotating axis is perpendicular to the gravity plane (vertical) but will also remain this vertical position while the angle of the Smart Tilt Module will change. Therefore this mode can be used to keep Gowing vertical while adjusting the (seating) frame where Gowing is mounted on. The automatic mode will be stopped when the angle of the Smart Tilt Module is stable for 30 seconds.

 buttons can still be used to adjust the tilt of Gowing. The adjustment angles are extended to $-10 .. 10^\circ$.

Mounting instructions

Mounting the control



Warning:

Attention for the position of the control of Gowing. If the user is controlling Gowing with the same hand as Gowing is supporting the arm. So using the left hand to control Gowing mounted to support the left arm. Then it is strongly recommended to place an extra switch in case the user is not able to reach for the controls any more.

The interface box of Gowing has a separate input for a push button that can be used as a “default” button. When this “default” button is pushed the blocking mechanism will be unblocked, the balance force will be minimised and the lift position will be lowered to the lowest position, giving the user the opportunity to control the Gowing again.

This button can be placed somewhere close to the head, the other hand, legs or any other position where the user is able to control a switch.

Maintenance instructions

Maintenance hardware

Do not place the device in direct sunlight or in the direct vicinity of a heat source, otherwise this might result in discolouration or scorching of plastic parts. Direct sunlight may reduce the lifetime of system parts and interfere with operation.

All housings, cables and connectors must be regularly inspected. If any housing or cable is visibly damaged, do not use the device. It is prohibited to physically modify Gowing. There are no serviceable parts inside Gowing. Contact Focal for any maintenance issues.

In case Gowing is not mounted on the mounting base it should always be stored in the case to prevent falling or other impacts that can damage the system.

Cleaning

Maintenance of Gowing is limited. Gowing can be cleaned using a moist cloth and a non-aggressive scour.

Reuse

To reuse Gowing, it has to be disassembled by a professional. Gowing must intensively be cleaned and inspected. The plastic parts of the buttons can be removed and replaced by new button parts. The arm fitting and elbow fitting have to be replaced.

Decommissioning



Appendix 1 Technical specifications

Specifications

Gowing		
Range of motion		
Up/Down	490	[mm] @ end of lever
Forward/Backward stroke	390	[mm] @ end of lever
Horizontal rotation	-69 .. + 69	[°]
Balance mass		
Up/Down		
Mass	0.25 to 5	[kg] @ end of lever
Electronic adjustable	0 .. 100	[%]
Lift capacity		
Up/Down		
Mass	0 .. 7	[kg] @ end of lever
Electronic adjustable	0 .. 100	[%]
Blocking mechanism		
Up/Down movement		
Blocking force	100	[N]
Index	14.5	[mm] @ end of lever
Forward/Backward movement		
Blocking force	100	[N]
Index	22.2	[mm] @ end of lever
Horizontal rotation		
Blocking force	100	[N]
Index	13.1	[mm] @ end of lever
Tilt function (Gowing integrated tilt module)		
Angle	-7 .. 7	[°]
Index	0.1	[°]
<i>Tilt function (Accessory: Smart Tilt Module)</i>		
<i>User adjustable angle</i>	<i>-10..10</i>	<i>[°]</i>
<i>Correction angle</i>	<i>-60 ..170</i>	<i>[°]</i>
<i>Index</i>	<i>0.1</i>	<i>[°]</i>
<i>Speed</i>	<i>5</i>	<i>[°/s]</i>
Mass		
Gowing body	6.8	[kg]
<i>Accessory: Smart Tilt Module</i>	<i>1.5</i>	<i>[kg]</i>
Operation voltage		
Nominal voltage	24	[V]
Absolute voltage range	12 .. 48	[V]
Operation current (@24V)		
Standby (maximum)	100	[mA]
During adjustments typical; maximum	800; 1000	[mA]
Power consumption		
Standby (maximum)	2.4	[W]
During adjustments typical; maximum	19; 24	[W]
Storage		
Temperature	-40 .. 85	[°C]
Humidity	35 .. 85	[%] non condensing
Mounting position		
Maximum allowed mounting angle	-45..45	[°]
Operating		
Temperature	-10 .. 50	[°C]
Humidity	35 .. 85	[%] non condensing
Degree of protection (DIN 40050)	IP40	

User interface 9-switch			
Type	9-switch		
Force (max)	1.76	[N]	
Travel (max)	0.5	[mm]	
Lifetime (min)	1.000.000	[cycles]	
Degree of protection (DIN 40050)	IP40		

Gowing dimensions

Dimensions of the Gowing are variable. This is because it is a product with moving parts and it is a product with different configurations.

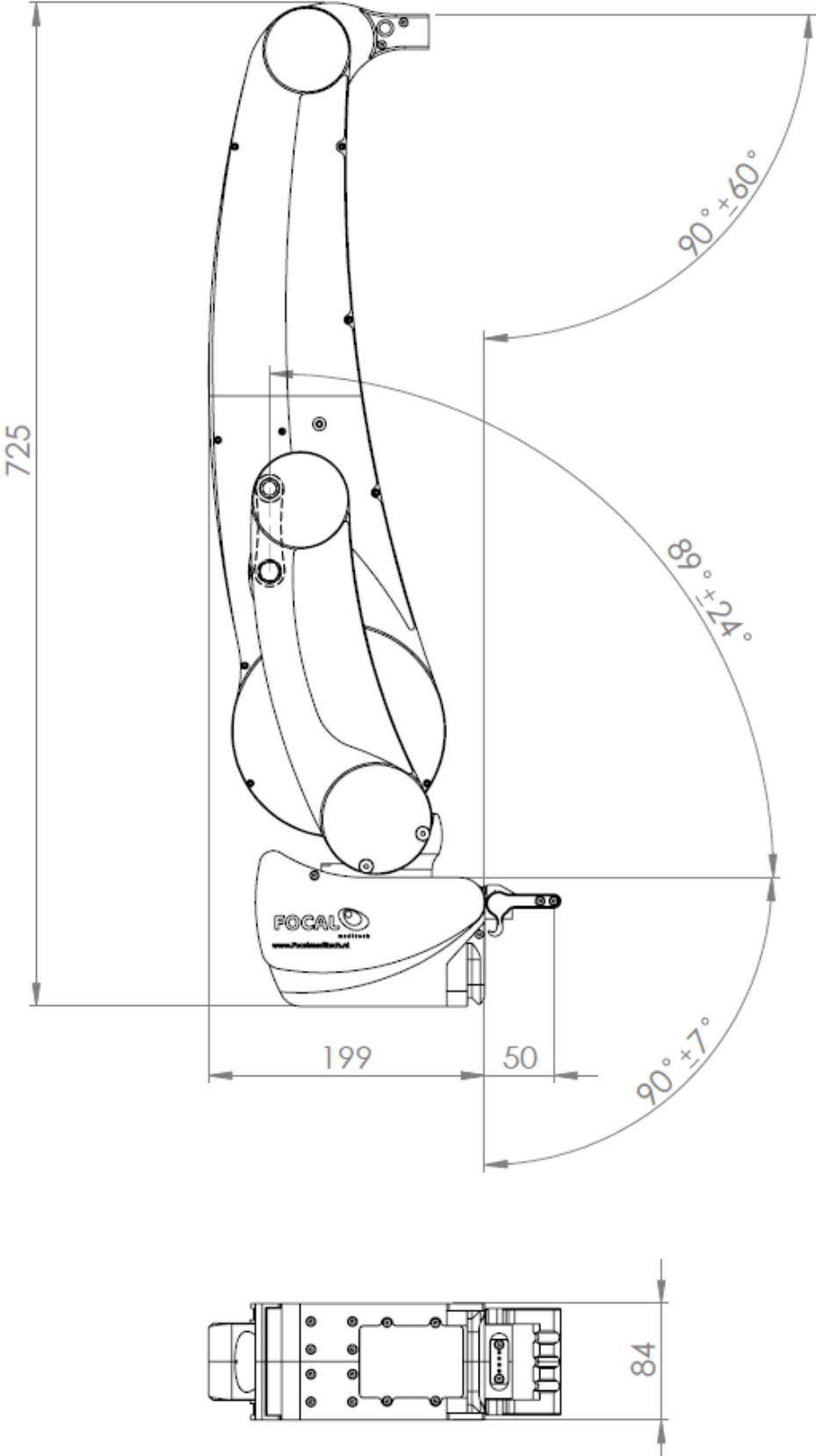

Dimensions Gowing (armrest excluded) in [mm]

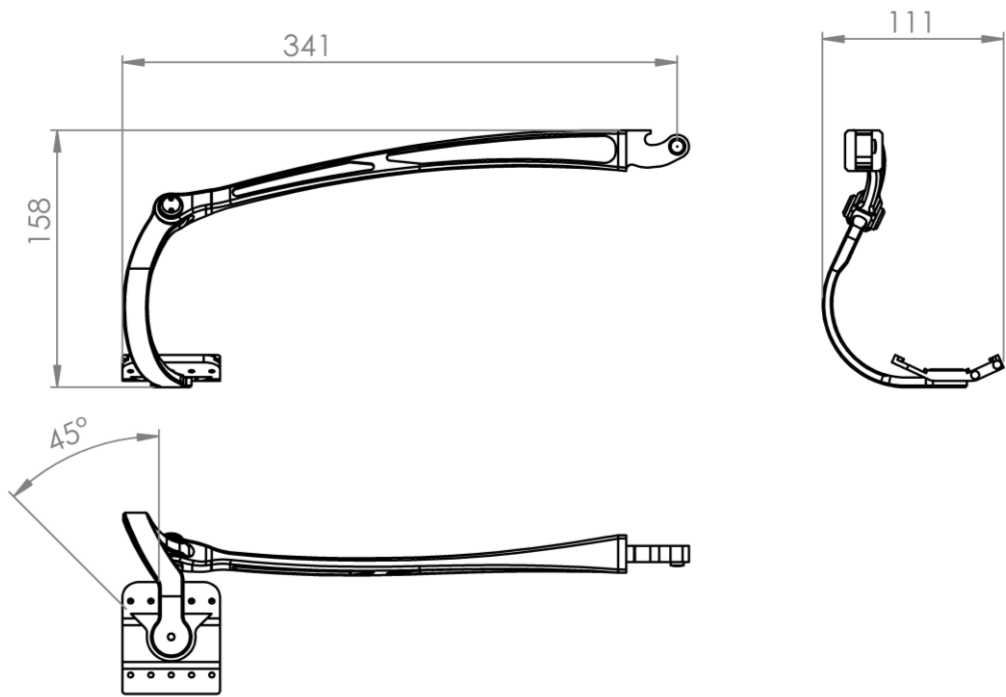

Dimensions Gowing armrest Large [mm]

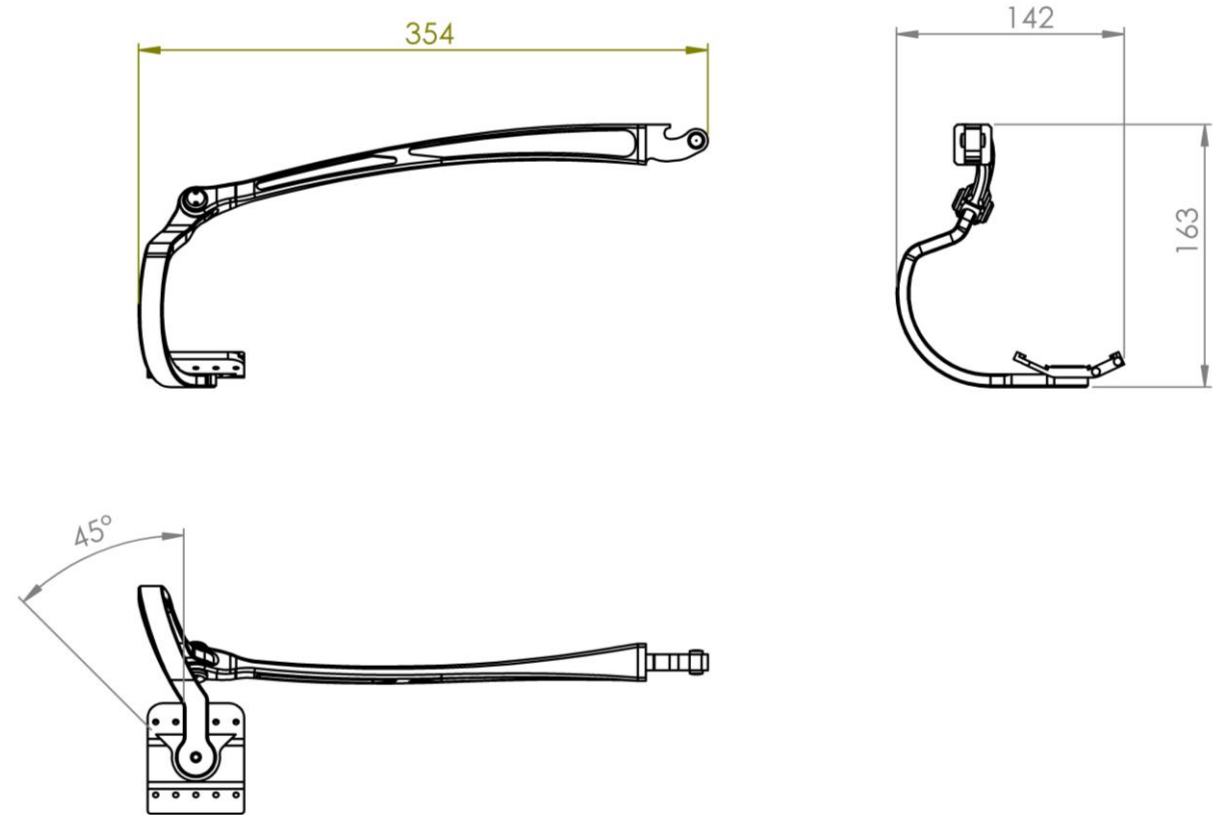

Dimensions Gowing armrest X-Large [mm]

Gowing content of case

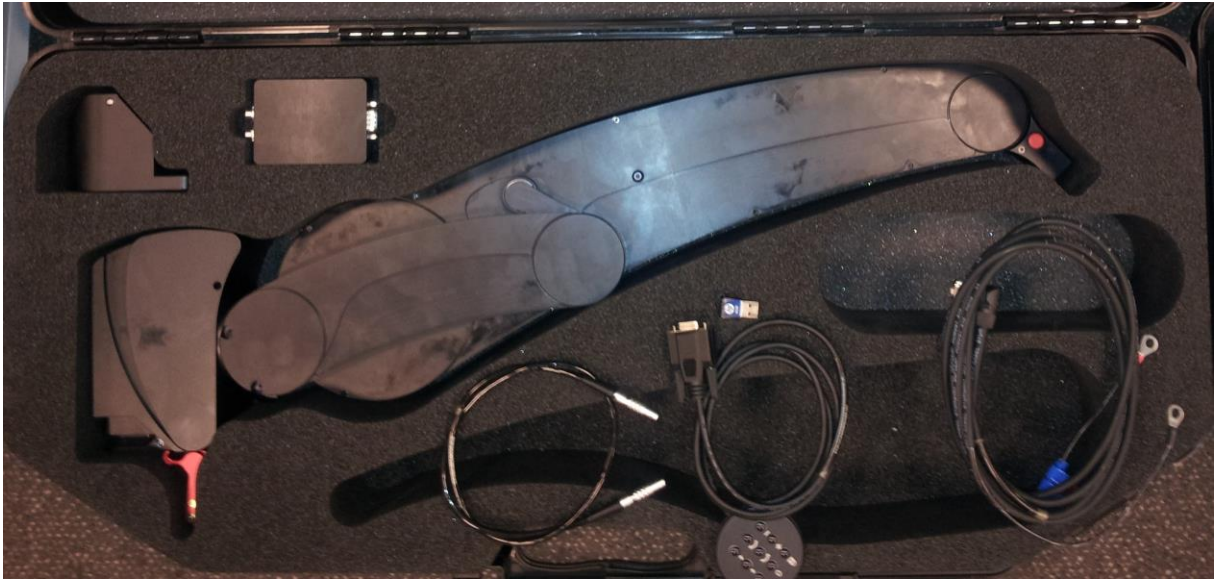

Content of case exclusive

To the case some parts must be added but these depend on the user:

- Loadarm with swing
- Arm fitting
- Elbow fitting
- Wrist support

Appendix 2 Part numbers

872FOCSAGWG**ABA921	Subassembly Gowing
872FOCSAGWG**ABA920	Subassembly Mounting Base
872FOCIFCL**ABB117	Case with inlay Gowing
872FOCAGWG**ABB163	9-switch+ UI board 9-switch + Focal bus cable 750
872FOCIFCL**ABB378	Battery power cable (Angle)
872FOCSAGWG**ABB122	Loadarm with arm swing right (Large)
872FOCSAGWG**ABB123	Loadarm with arm swing left (Large)
872FOCSAGWG**ABB212	Loadarm with arm swing left (X-Large)
872FOCSAGWG**ABB213	Loadarm with arm swing right (X-Large)
872FOCSAGWG**ABB144	Subassembly wrist support (Right)
872FOCSAGWG**ABB145	Subassembly wrist support (Left)
872FOCSAGWG**ABC040	Subassembly Elbow fitting Left (X-Large)
872FOCSAGWG**ABC041	Subassembly Elbow fitting Right (X-Large)
872FOCSAGWG**ABB140	Subassembly Elbow fitting Left (Large)
872FOCSAGWG**ABB141	Subassembly Elbow fitting Right (Large)
872FOCSAGWG**ABB214	Subassembly Elbow fitting Left (Small)
872FOCSAGWG**ABB215	Subassembly Elbow fitting Right (Small)
872FOCSAGWG**ABB130	Subassembly Armfitting size 1 Right
872FOCSAGWG**ABB131	Subassembly Armfitting size 1 Left
872FOCSAGWG**ABB132	Subassembly Armfitting size 2 Right
872FOCSAGWG**ABB159	Subassembly Armfitting size 2 Left
872FOCSAGWG**ABB133	Subassembly Armfitting size 3 Right
872FOCSAGWG**ABB134	Subassembly Armfitting size 3 Left
872FOCSAGWG**ABB135	Subassembly Armfitting size 4 Right
872FOCSAGWG**ABB136	Subassembly Armfitting size 4 Left
872FOCSAGWG**ABB631	Subassembly Armfitting size 5 Right
872FOCSAGWG**ABB630	Subassembly Armfitting size 5 Left
872FOCIFCL**ABB216	Sticker package for Gowing Grey carbon look
872FOCIFCL**ABB217	Sticker package for Gowing Black carbon look
872FOCSAGWG**ABB532	Subassembly Bracket lever
872FOCASTM**ABB741	Smart Tilt Module Gowing

**) means each number between 00 and 99 (for internal use Focal)

Appendix 3 Used materials

Part	Focal number	Material
872FOCSAGWG**ABA921	Subassembly Gowing	Aluminium 6082T6+ RVS(AISA 304)
872FOCSAGWG**ABA920	Subassembly Mounting Base	Aluminium 6082T6+ RVS(AISA 304)
872FOCAGWG**ABB163	9-switch+ UI board 9-switch + Focal bus cable 750	
872FOCSAGWG**ABB122	Load arm with arm swing	Aluminium 6082T6+Aisi + RVS(AISA 304)
872FOCSAGWG**ABB123		
872FOCSAGWG**ABB212		
872FOCSAGWG**ABB213		
872FOCSAGWG**ABB144	Subassemblies wrist support	Aluminium 6082T6+Aisi + RVS(AISA 304) + NEOPRENE+ Celrubber+ POM
872FOCSAGWG**ABB145		
872FOCSAGWG**ABB140	Subassemblies Elbow fitting	Aluminium 6082T6+Aisi + RVS(AISA 304) + NEOPRENE+ Celrubber
872FOCSAGWG**ABB141		
872FOCSAGWG**ABB214		
872FOCSAGWG**ABB215		
872FOCSAGWG**ABC040		
872FOCSAGWG**ABC041		
872FOCSAGWG**ABB130	Subassemblies Arm fitting	Aluminium 6082T6+Aisi + NEOPRENE+ POM
872FOCSAGWG**ABB131		
872FOCSAGWG**ABB132		
872FOCSAGWG**ABB159		
872FOCSAGWG**ABB133		
872FOCSAGWG**ABB134		
872FOCSAGWG**ABB135		
872FOCSAGWG**ABB136		
872FOCSAGWG**ABB630		
872FOCSAGWG**ABB631		

Appendix 4 Mounting instructions Gowing

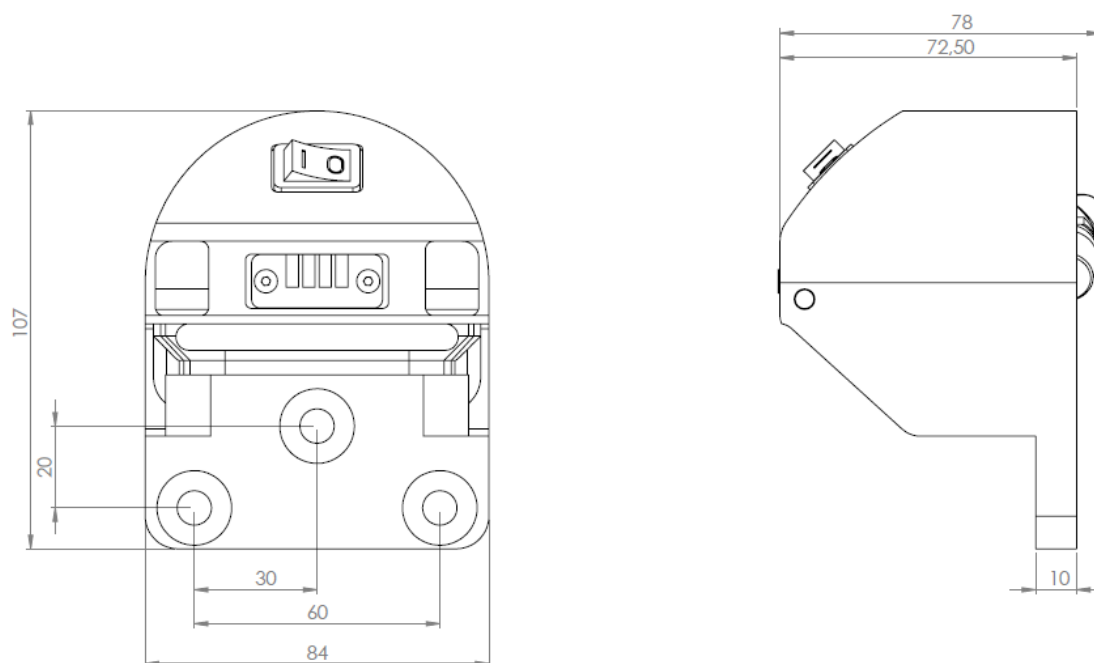



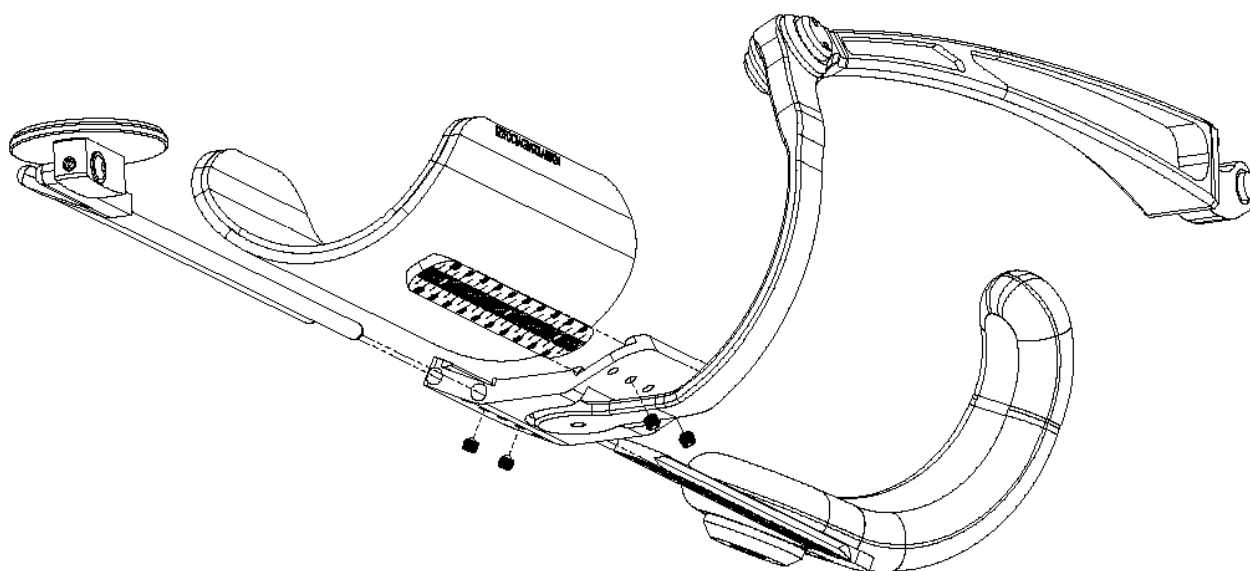

Measures of the mounting base of Gowing



Assembly of a left arm support.

Appendix 5 Quick Chart

		
Button	Function	Illumination / Buzzer
	Block / Unblock all axes	Block 
		Unblock 
	Adjust balance forces	
	Tilt Gowing to 0 degrees (default)	
	 Adjust tilt angle	
	Disable lift functionality (default)	
	 Adjust lift position	
	Movement has reached end of stroke	
	Command from user is not executed to prevent collision	
	Error occurred	
<div style="display: flex; justify-content: space-around;">   </div>		
Remove Gowina		
<div style="display: flex; justify-content: space-around;">   </div>		

Appendix 6 Troubleshooting guide

When Gowing has to be transported it is required to store it in its case which is part of the system.

Gowing saves errors for maintenance and service reasons and is able to show these errors in the troubleshoot mode. In the troubleshoot mode the leds and buzzer of the 9-switch will be used to show the errors of Gowing.

Entering the troubleshoot mode:

- Turn Gowing off and wait for 5 seconds

-  Push and hold the center button of the 9-switch while turning on Gowing and keep this button pushed until the blue leds on the switch lid.

-  Push the upper left button. If no led lids, no errors are known.

Error messages

Error messages are displayed using light and beep signals. The red and blue leds of the 9-switch will show the error message. As a led lids, the buzzer will produce a sound. The green led is used to separate the various errors. If the green led lids long and the buzzer sounds longer, this indicates that the sequence starts again. Leaving the troubleshoot mode can be done by switching off Gowing.

Example:

	Error message	Indication next error	Error message	Indication end of error messages
Buzzer	■ ■ ■		■ ■ ■ ■ ■	■■■■■
Leds	■	■ ■ ■ ■	■ ■ ■ ■ ■	■ ■ ■ ■ ■

Time ->

Error list

■	■	Error 1.1
■	■ ■	Error 1.2
■	■ ■ ■	Error 1.3
■	■ ■ ■ ■	Error 1.4
■	■ ■ ■ ■ ■	Error 1.5
■ ■	■	Error 2.1
■ ■ ■	■ ■	Error 2.2
■ ■ ■	■ ■ ■	Error 2.3
■ ■ ■	■ ■ ■ ■	Error 2.4
■ ■ ■	■ ■ ■ ■ ■	Error 2.5
■ ■ ■ ■	■	Error 3.1
■ ■ ■ ■	■ ■	Error 3.2
■ ■ ■ ■	■ ■ ■	Error 3.3
■ ■ ■ ■	■ ■ ■ ■	Error 3.4
■ ■ ■ ■	■ ■ ■ ■ ■	Error 3.5
■ ■ ■ ■ ■	■	Error 4.1

For all these errors please contact your sales representative.

Appendix 7 Declaration of conformity



listening
creating
improving

WE:			
MANUFACTURER:	Focal Meditech B.V.		
ADDRESS:	Droogdokkeneiland 19 5026 SP Tilburg Netherlands		
TEL:	+31 13 533 3103		
FAX:	+31 13 533 5004		
WEBSITE:	www.focalmeditech.nl		
HEREBY DECLARE THAT THE DEVICE:			
DEVICE (MODEL):		DESCRIPTION	
872FOCSAGWG**ABA921		Subassembly Gowing	
872FOCSAGWG**ABA920		Subassembly Mounting Base	
872FOCSAGWG**ABB163		9-switch+ UI board 9-switch + Focal bus cable 750	
872FOCSAGWG**ABB122		Loadarm with arm swing right (Large)	
872FOCSAGWG**ABB123		Loadarm with arm swing left (Large)	
872FOCSAGWG**ABB212		Loadarm with arm swing left (X-Large)	
872FOCSAGWG**ABB213		Loadarm with arm swing right (X-Large)	
872FOCSAGWG**ABB144		Subassembly wrist support Right	
872FOCSAGWG**ABB145		Subassembly wrist support (Left)	
872FOCSAGWG**ABC040		Subassembly Elbow fitting Left (X-Large)	
872FOCSAGWG**ABC041		Subassembly Elbow fitting Right (X-Large)	
872FOCSAGWG**ABB140		Subassembly Elbow fitting Left (Large)	
872FOCSAGWG**ABB141		Subassembly Elbow fitting Right (Large)	
872FOCSAGWG**ABB214		Subassembly Elbow fitting Left (Small)	
872FOCSAGWG**ABB215		Subassembly Elbow fitting Right (Small)	
872FOCSAGWG**ABB130		Subassembly Armfitting size 1 Right	
872FOCSAGWG**ABB131		Subassembly Armfitting size 1 Left	
872FOCSAGWG**ABB132		Subassembly Armfitting size 2 Right	
872FOCSAGWG**ABB159		Subassembly Armfitting size 2 Left	
872FOCSAGWG**ABB133		Subassembly Armfitting size 3 Right	
872FOCSAGWG**ABB134		Subassembly Armfitting size 3 Left	
872FOCSAGWG**ABB135		Subassembly Armfitting size 4 Right	
872FOCSAGWG**ABB136		Subassembly Armfitting size 4 Left	
872FOCSAGWG**ABB631		Subassembly Armfitting size 5 Right	
872FOCSAGWG**ABB630		Subassembly Armfitting size 5 Left	
872FOCASTM**ABB741		Smart Tilt Module Gowing	
COMPLY WITH THE FOLLOWING STANDARDS:			
NUMBER	TITLE		
EN ISO 14971	Medical devices - Application of risk management to medical		
ISO 10993-1	Biological evaluation of medical devices - evaluation and testing		
EN12182	Assistive products for persons with disability - General requirements and test methods		
IEC 60601-1	Medical electrical equipment : General requirements for basic safety and essential performance		
IEC 62079	Preparation of instructions		
AND IF APPLICABLE, COMPLY WITH THE FOLLOWING DIRECTIVES:			
NUMBER	TITLE		
93/42/EEC	Medical Device Directive		
89/336/EEC	Electromagnetic Compatibility Directive		
73/23/EEC	Low Voltage Equipment Directive		
93/68/EEC	CE Marking Directive		
WITH LVFS 2001:6 TRANSPONDING THE EUROPEAN MEDICAL DEVICE DIRECTIVE 93/42/EEC.			
SIGNED AT:	Tilburg, The Netherlands		P.C.M. Groenland Directeur
DATE:	1-11-2015	SIGNATURE:	

Appendix 8 Conditions and Warranty

Conditions and Warranty: supply through a representative of Focal Meditech

Conditions and Warranty in the case of supply through a representative of Focal Meditech are subject to conditions of the national or local representative and in accordance with national law.

Conditions and Warranty: direct supply by Focal Meditech BV to consumers

In the case of direct supply by Focal Meditech BV to paying parties being consumers, Conditions and Warranty are subject to the Consumer General Terms and Conditions V. 2014 issued by Koninklijke Metaalunie and in accordance with national law.